

Coloring Your Aircraft

This is a description of the PSD templates. You have to use **Photoshop** or **Gimp** to take advantage of the predefined layer structure. This tutorial will not explain how to use Photoshop or Gimp. Please refer to the related manuals. In this example we will use the files for the **Cessna C172**.

- **Open the fuselage01_color.psd and fuselage0_color.psd.**

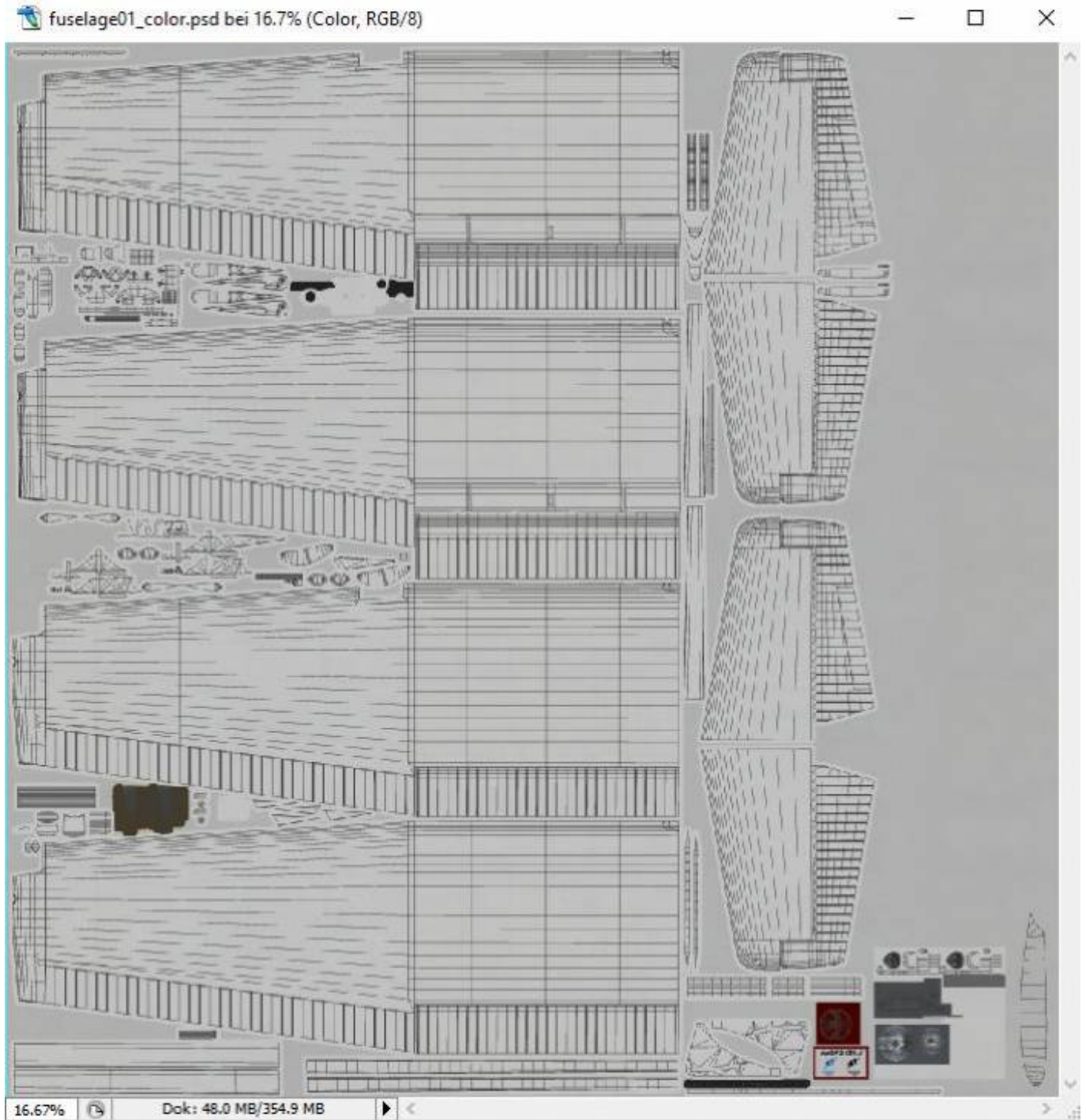

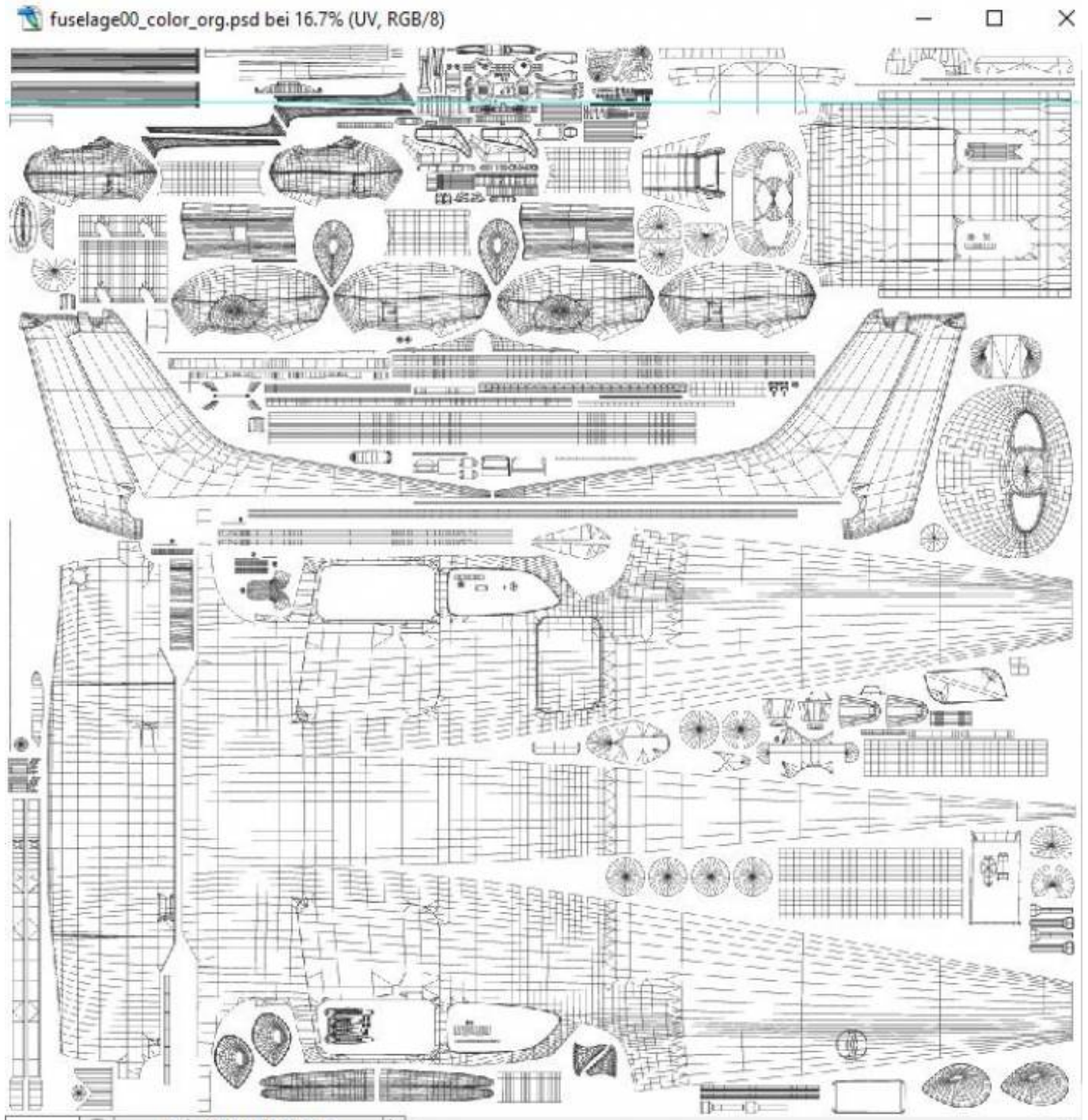

This is the structure of the layer groups that you will see in PS or Gimp.

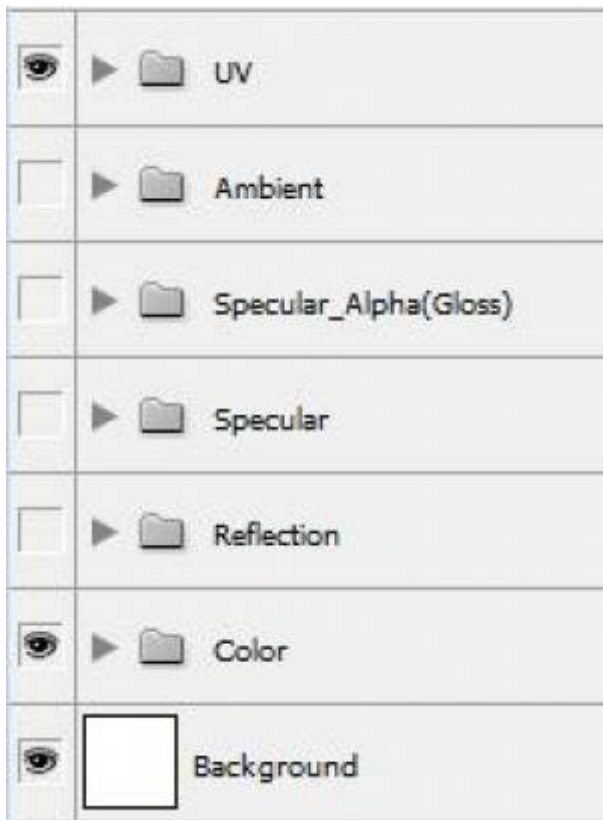

This is a directory listing of the graphics files that you will see in Aerofly FS 2 aircraft folders.

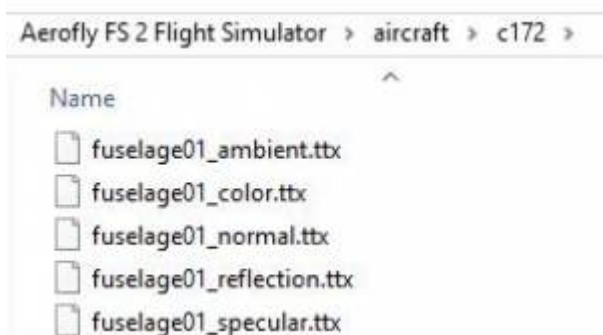

Note - As you can see, the PSD layer structure corresponds strongly with the files of the c172. This means, you can use the layer groups to output your repaint to the required BMP files.

UV layer group

This group contains the display of the 3D mesh. This will give you orientation while repainting the aircraft. If left on when saving a BMP, the gridlines will appear on the aircraft. During repaint process the mesh can help to localize certain positions on the aircraft. Before we finally save a BMP, this group has to be switched off!

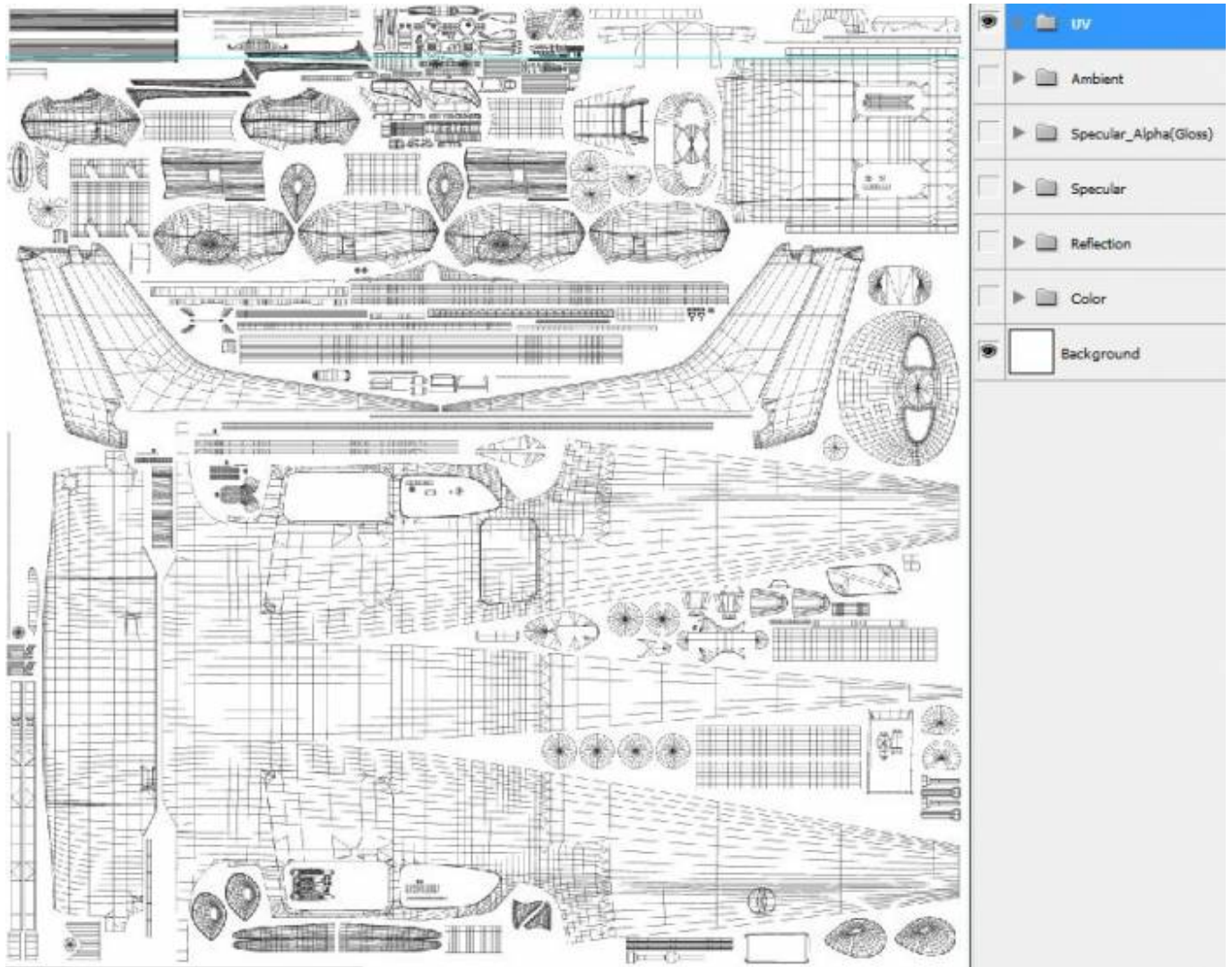

Here the fuselage00_color.psd has been saved with both layer groups on: **Color + UV**. The 3D mesh on the aircraft facilitates the identification of positions.



Detail of 3D mesh on UV layer

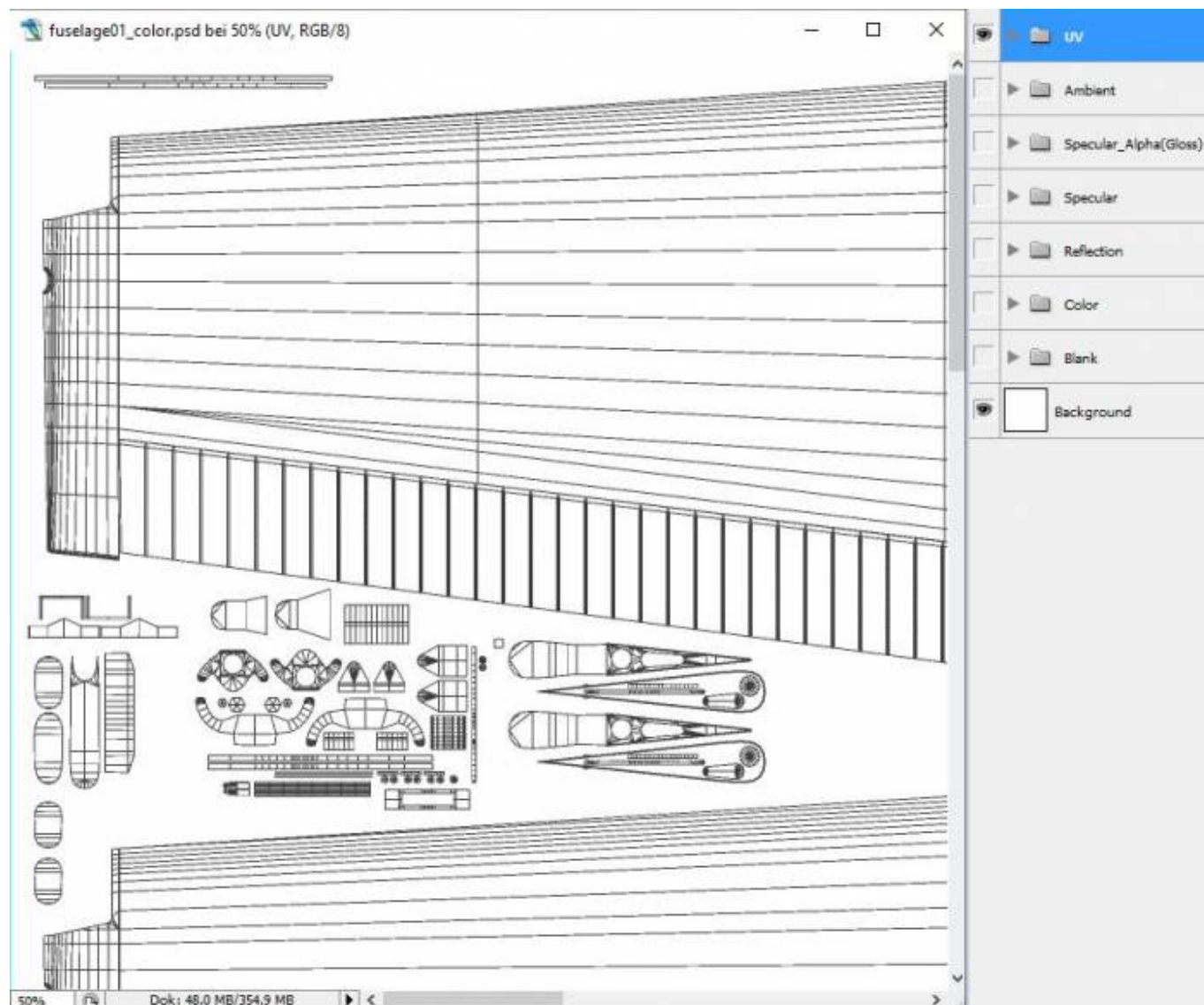

Color layer group

This is the main layer group for our repainting.

As you can see below, the Color layer group contains several subgroups like Effects, Liveries, Metal, Blank.

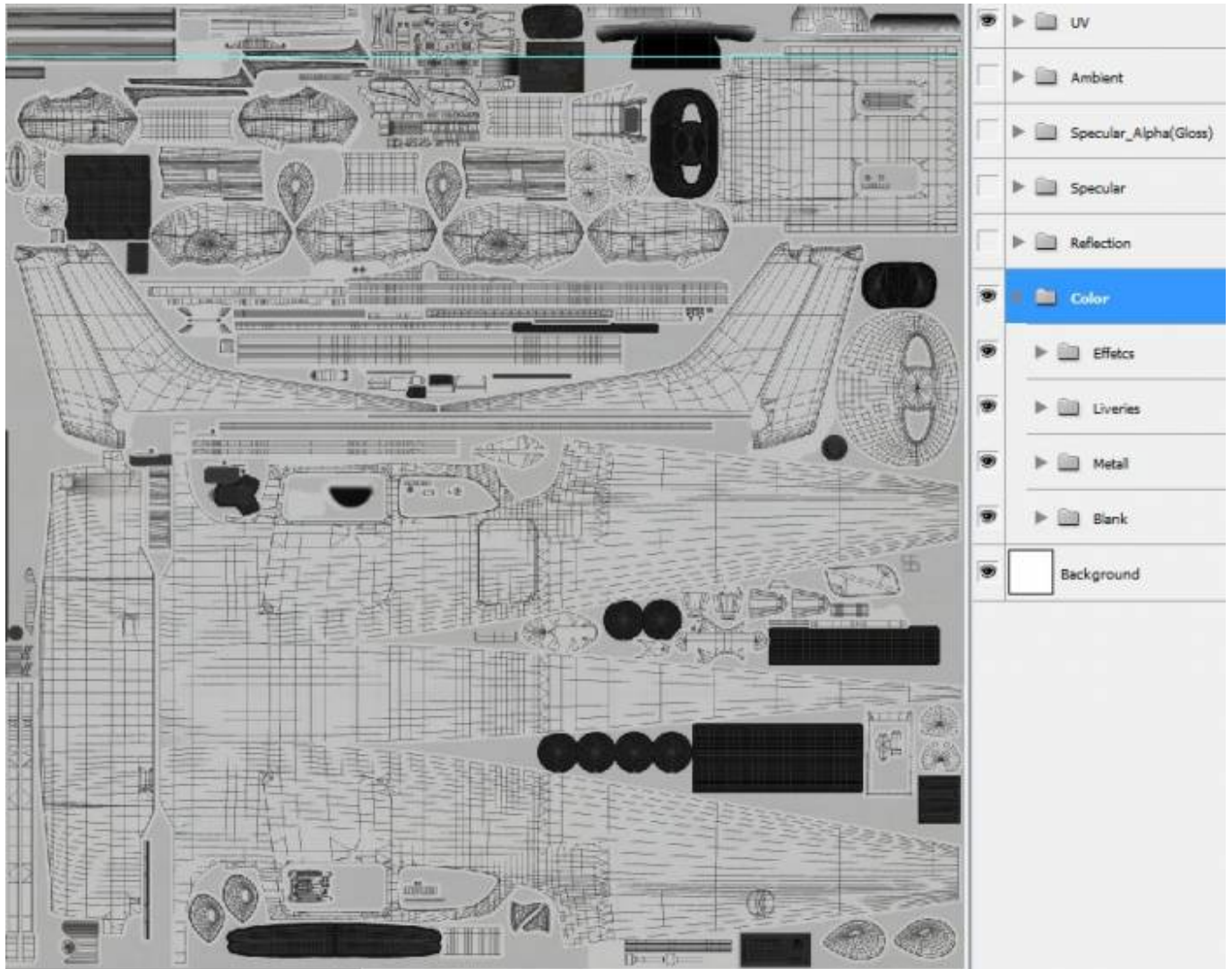

Next, switch off all layers except the single color layer. Now let's change the basic color of our aircraft to yellow.

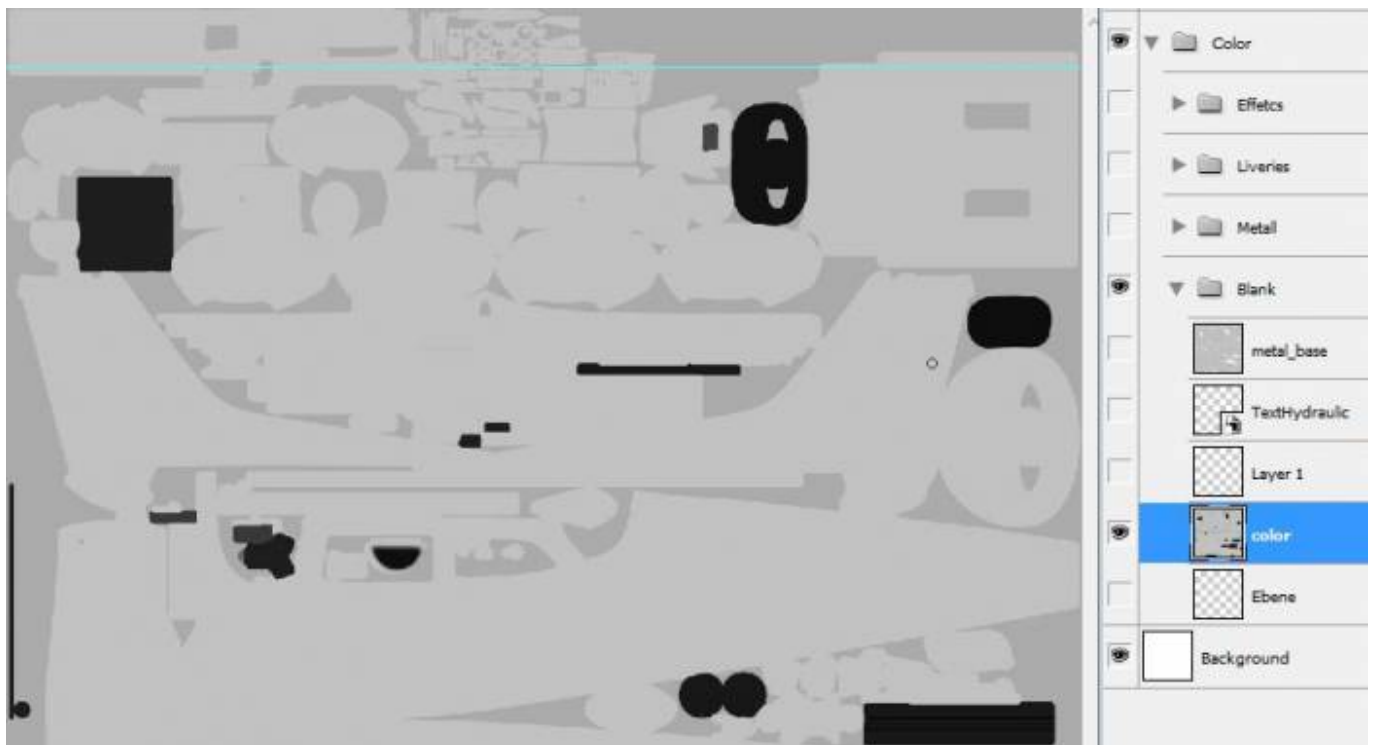



- Do not place lines, text and other objects onto this layer.
- Use separate layers for other objects. This allows easier adjustment of a line above the color drawing. You can move it, bend it, cut it without touching the base layer. Also you can copy and mirror the line layer to cover the other side of the fuselage or wing. The same is valid for text information. I even have separate text layers, which allows different fonts, positions, text sizes etc.

Liveries Group

In the template you can see the design layers in the Liveries group.

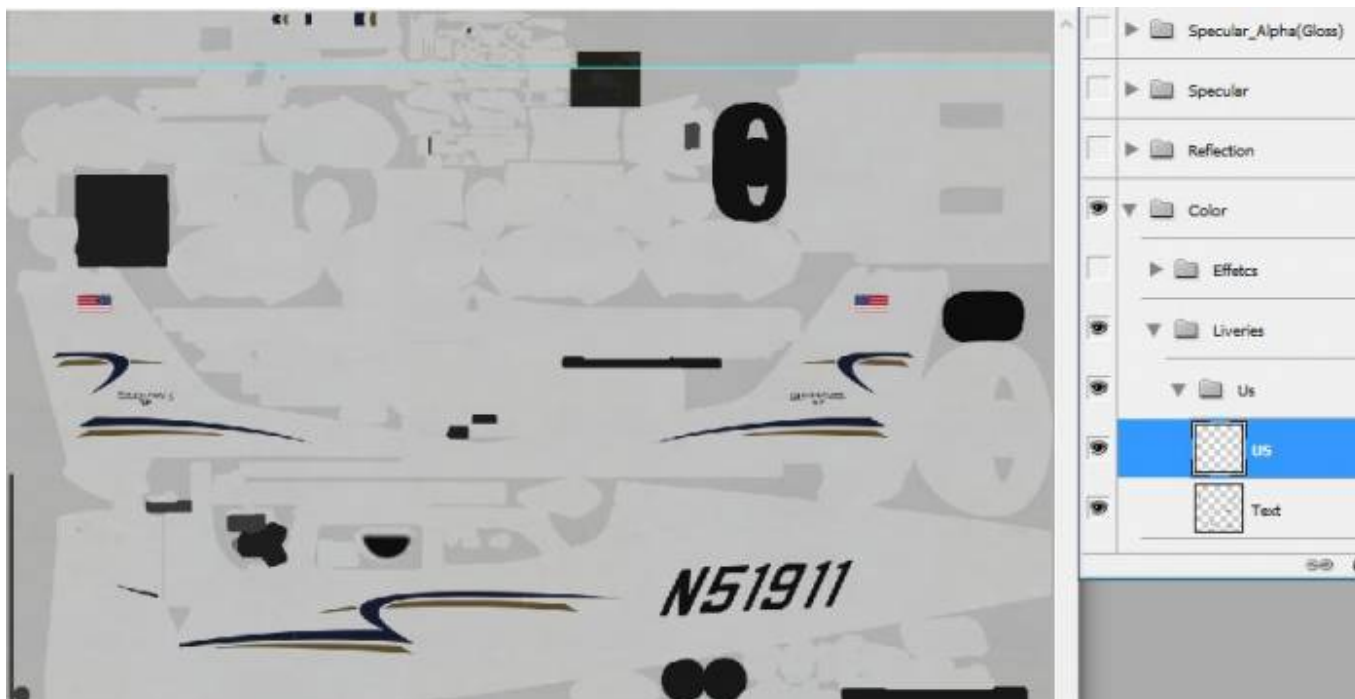

Adding new layers with your designed content makes it easier.

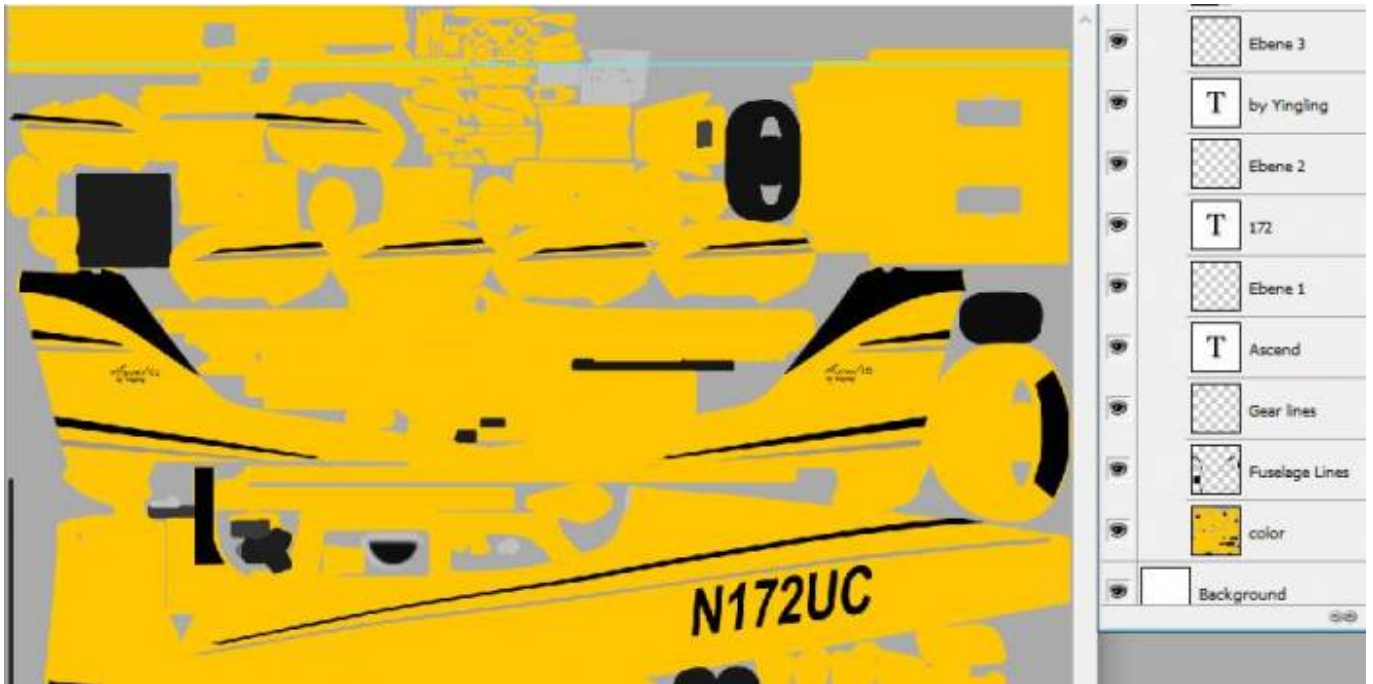

If you finished repainting, switch on all necessary layers of the color layer group, switch off all other layer groups and save your work as `_color.bmp`, 24 bit. This will be used for conversion to the final `_color.ttx` file.

Ambient layer group

In computer graphics, ambient occlusion is a shading and rendering technique used to calculate how exposed each point in a scene is to ambient lighting. In aerofly FS 2 it is a 24 bit grey scale map.

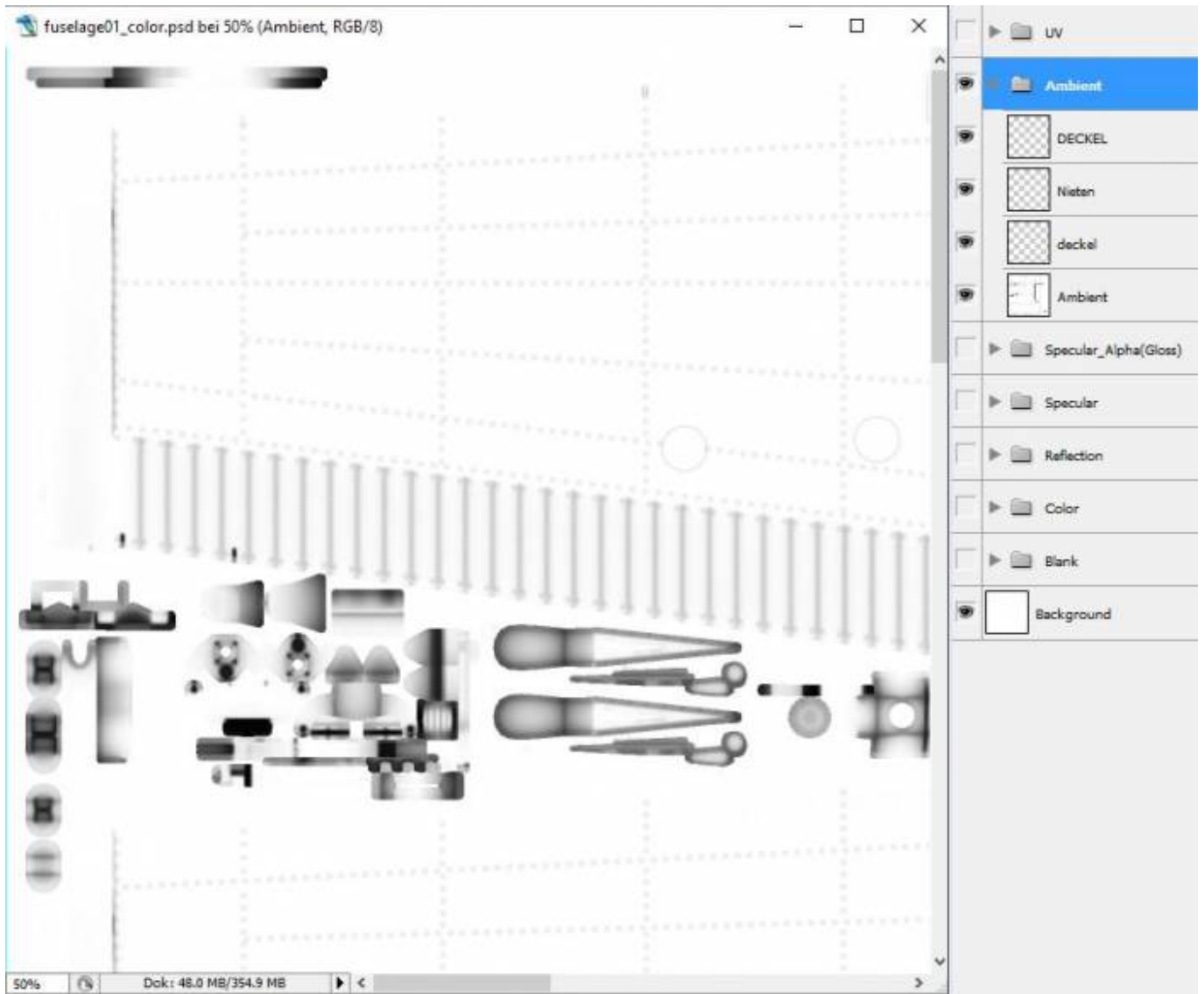

Note this groove line between the wing and the wing tip. In the color layer there is just yellow color. In the reflection layer we see the elevated rivets. But in the ambient layer the groove line is clearly visible.

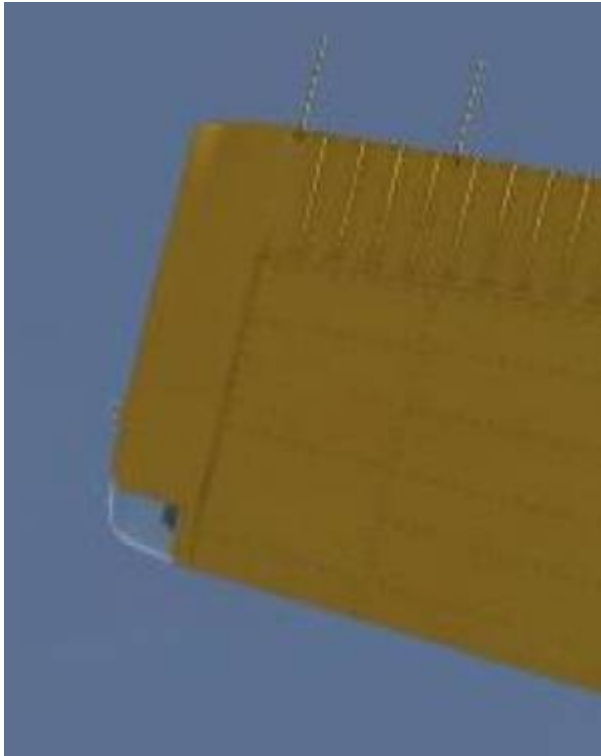

Note the rivets as small circles in this example (note: contrast has been modified for the tutorial).

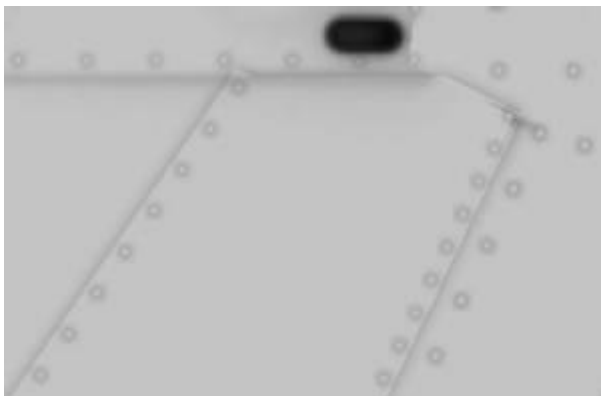

- If you modified the ambient layer group, switch on all necessary layers, switch off all other layer groups and save your work as `_ambient.bmp`, 24 bit. This will be used for conversion to the final `_ambient.ttx` file.

Specular and Specular_Alpha layer group

24-bit color map with each color value representing the brightness for the Red, Green and Blue (RGB)

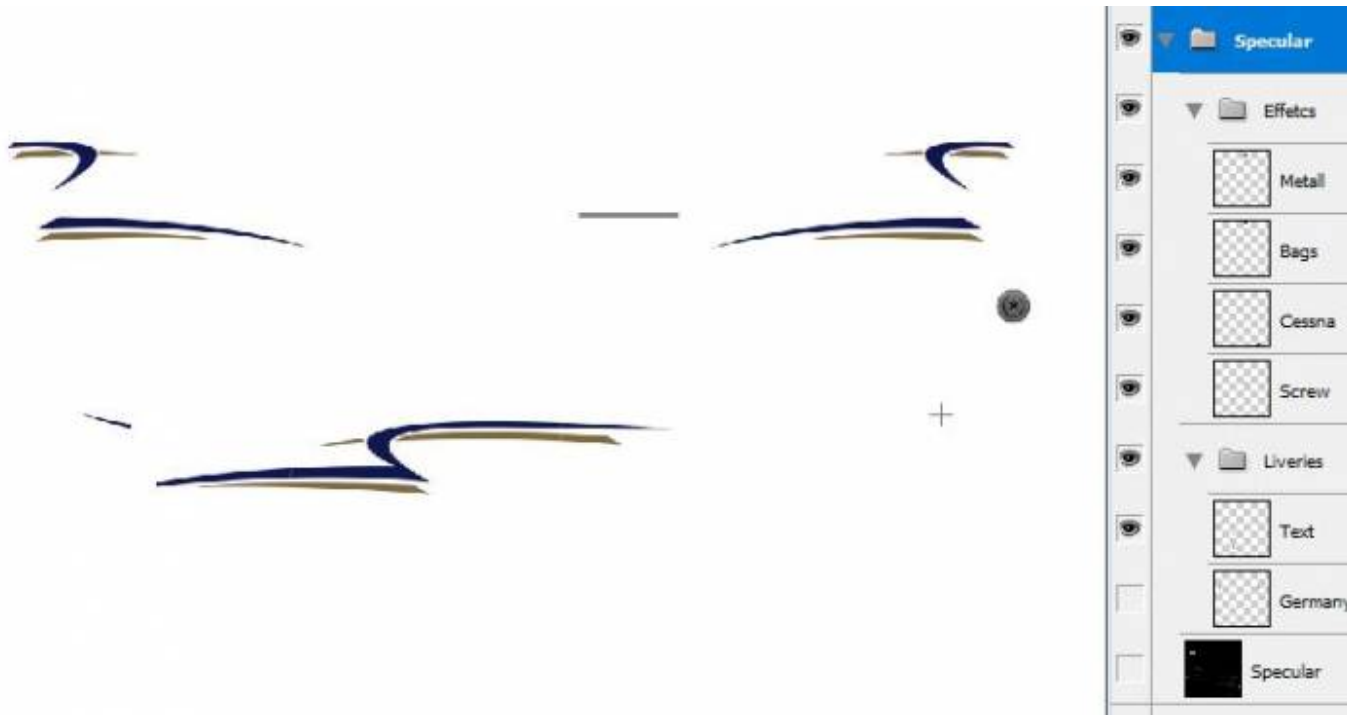

- As you can see, this group contains the signs of the original painting (note: for better demonstration, the black layer has been switched off)
- **If we do not modify these layers, the shimmering will be visible on our aircraft.**



If you modified the specular layer group, switch on all necessary layers, switch off all other layer groups and save your work as `_specular.bmp`, 24 bit. This will be used for conversion to the final `_specular.ttx` file.

Reflection layer group

This group controls the reflection strength of a surface. In aerofly FS 2 it is a grey scale layer group where black means no reflection and white means 100% reflection.



In this example I copied the aircraft lines onto the reflection layer and selected a bright grey



If you don't switch on the black layer the reflection layer will show white showing a perfect polished aluminum



Here is another detail of reflection layer group

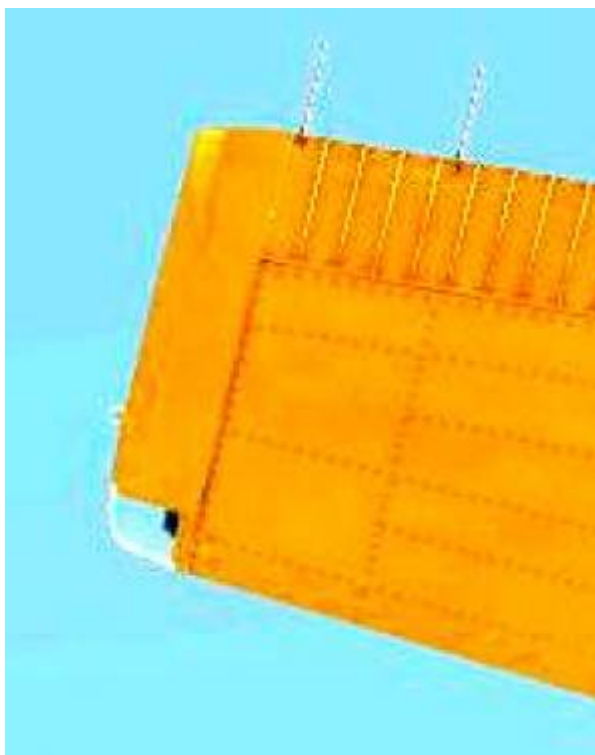
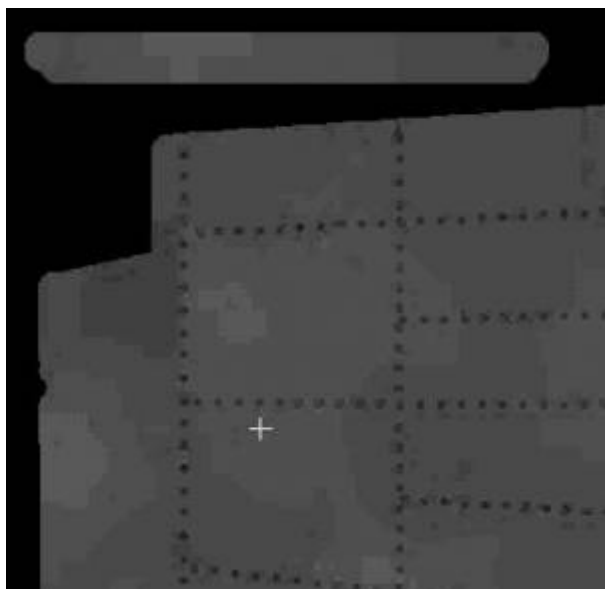

The yellow is all plain-colored over the whole color layer. But in the reflection group the surface is not a uniform grey tone, it differs slightly in kind of patches. This creates a very realistic surface structure (note: contrast of screenshots has been modified to better display the patches).

- If you modified the reflection layer group, switch on all necessary layers, switch off all other layer groups and save your work as `_reflection.bmp`, 24 bit. This will be used for conversion to the final `_reflection.ttx` file.

As we have seen there exist several layer groups corresponding to different .TTX files of the aircraft. It is important to check and modify all of the related layer groups for our repaints. We output several different BMP files with fixed naming conventions. The structure is given by the templates provided by IPACS, the aerofly FS 2 developers. The result will be a high quality texture for our aircrafts.

From:

<http://www.aerofly.com/dokuwiki/> - **Aerofly FS Wiki**

Permanent link:

<http://www.aerofly.com/dokuwiki/doku.php/sdk:coloring?rev=1488336214>

Last update: **2017/03/01 03:43**

